

DESCRIPTION

BACHFIRE Z is an Automatic Fire Curtain that in the case of fire, limits and controls the fire, with classification E120 and EW 20. This system can be adapted to irregular geometric perimeters open or closed, in order to avoid vertical beams.

The curtain is composed of fibreglass fabric with polyurethane coating on both sides seamed with reinforced steel wire and fixed to a 2 mm plate inside the headbox and to the bottom bar. Galvanized steel elements such as headbox, side guides and bottom bar.

All the system is driven by at least one 230 V tubular motor with special gravity fail-safe system.

The control panel for automatic curtains (CBM), has a nominal input voltage of 115 V / 220 V and an output voltage of 230 V / 24 V.

Uninterruptible Power Supply (UPS System) with autonomy for up to 6 hours exists in all control panels.

Tested in accordance with EN1634-1 and classified in accordance with EN 13501-2.

CLASSIFICATION

E 120

EW 20



bachfire Z

OPERATION

The system can be activated by a SHEV, fire alarm contact, internal fire and smoke detection devices, or manual emergency buttons. In the event of a fire, the Control Panel (CBM), receives the signal alarm, and the automatic curtain deploys automatically, with the controlled and safe constant speed of descent even following total power loss on all curtains. If there is a false alarm the curtains return to the stand-by position automatically after resetting the alarm from the main Fire Management Systems. In case of main power loss, the curtain will remain fully retracted thanks to the battery backup system.

FABRIC

The fibreglass fabric resists up to 1,100°C sewed as a concertina shape. The polyurethane coating on both sides guarantees mechanical stability when handling the fabric not only in the sewing process but also during the installation. All seams are done with reinforced stainless steel wires with a coating of Kevlar.

HEADBOX

Galvanized Steel headbox 1.2 mm thickness with different possibilities to adapt to different architectural spaces, and maintenance requirements. Dimensions of the headbox vary depending on the width and height of the curtain.

SIDE GUIDES

Galvanized Steel from 1.5 to 3 mm in thickness and different dimensions depending on the width and height of the curtain.

ROLLER

Galvanized Steel of 3 mm thickness and 42 mm diameter with a chain connected to an external motor.

BOTTOM BAR

Galvanized Steel of 1.2 mm thickness.

ELECTRIC MOTOR

Motor: 230 V / brake 24 V.

Maximum power: 120 Nm / 240 W.

Maximum current: 2 A.

Average linear speed: not defined (depends on the dimension of the curtain).

CBM CONTROL PANEL

Receives the signal alarm from the Fire Management System and controls the movement of the curtains. Visual and acoustic alert system.

Dimensions (W x H x D): 400 x 500 x 200 mm.

Input: 115 or 220 V 50Hz.

Output: 24 V / 230 V.

Battery: 2 x 12 V 7,5 Ah rechargeable (up to 6 hours autonomy).

OPTIONAL EXTRAS

RAL coating: headbox, side guides, bottom bar.

Stainless steel elements: headbox, side guides, bottom bar, screws, rivets.

CBM control panel: special designs with additional information output, micro switches, communication with other devices, special battery backup, possibility of delaying curtain deployment.

Emergency button: pushing this button the curtain deploys immediately.

Note: other requirements and customized solutions on demand.

HEADBOX

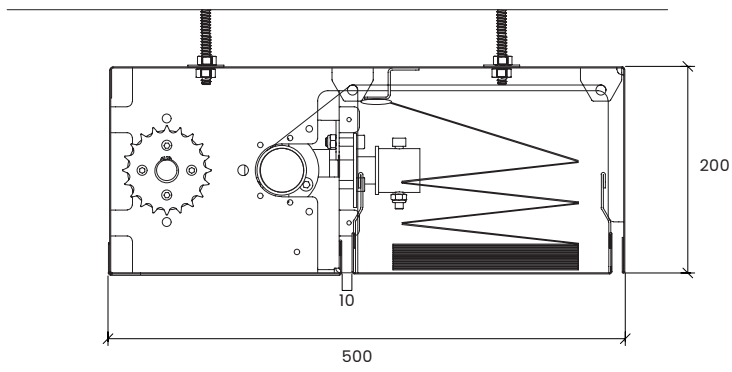

HEADBOX DETAIL FABRIC UP

SIDE GUIDE

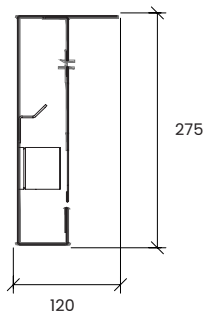

SIDE GUIDE FOR OPEN PROFILE

BOTTOM BAR

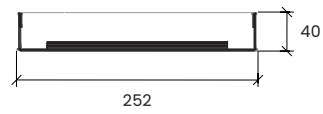
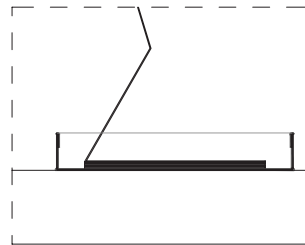

BOTTOM BAR DOWN

DIFFERENT GEOMETRIES

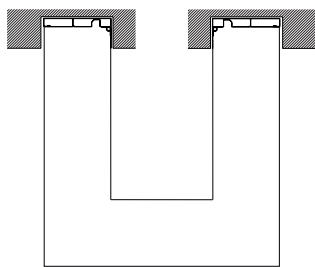

U SHAPE

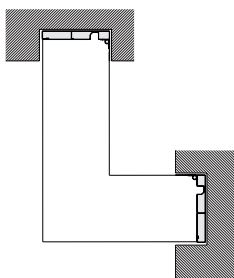

L SHAPE

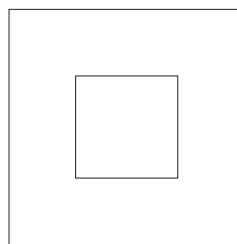

O SHAPE

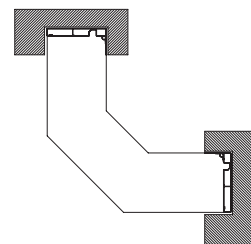

IRREGULAR SHAPE

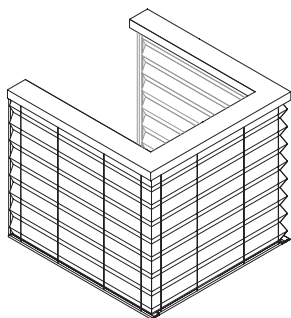

U SHAPE

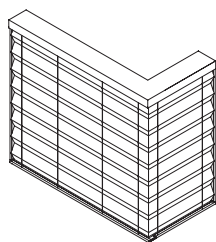

L SHAPE

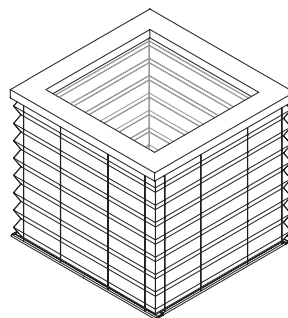

O SHAPE

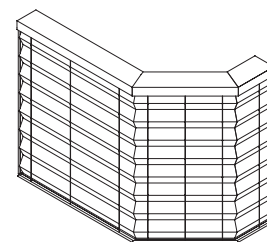

IRREGULAR SHAPE

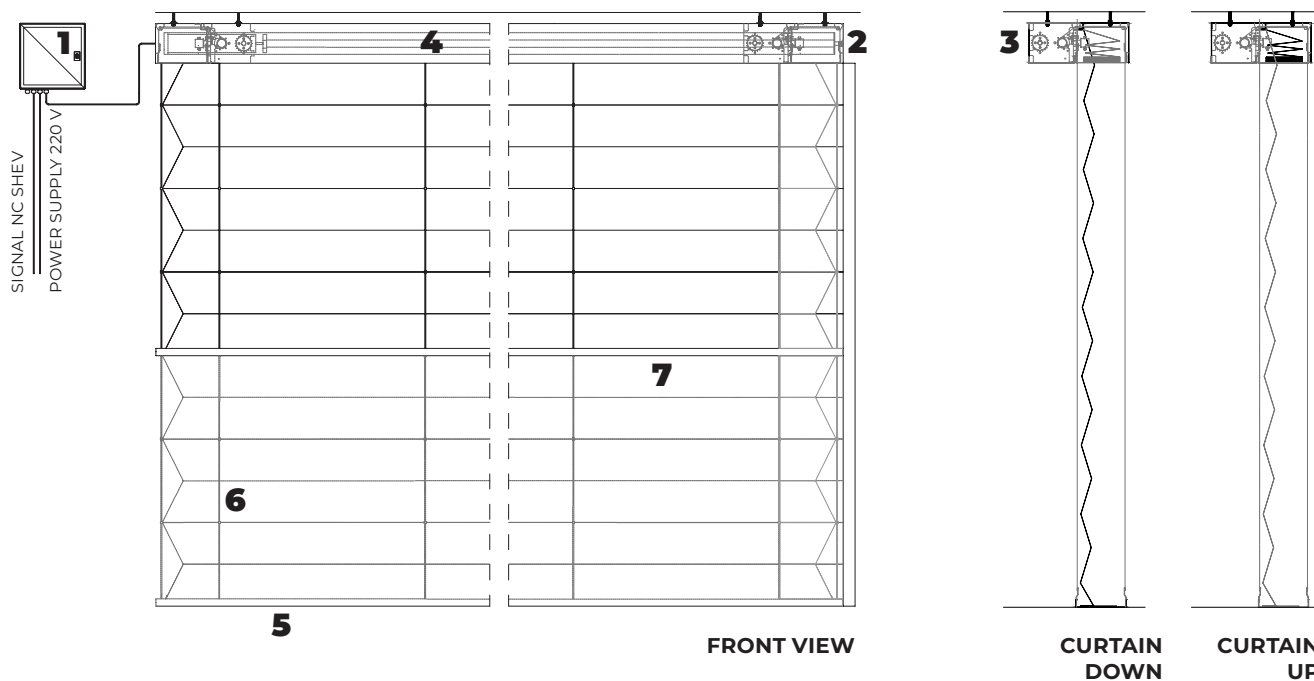

- | | |
|-----------------------------|--------------------------------|
| 1. control panel CBM | 5. galvanised steel bottom bar |
| 2. tubular motor 230 V | 6. lifting strips |
| 3. galvanised steel headbox | 7. concertina fabric |
| 4. galvanised steel roller | |