

INSECT & BIRD MESH



PRODUCT FEATURES

In industry, particularly in the food industry, it's necessary to comply with strict hygiene regulations. Especially where heavy air humidity is prevalent, there's a need for natural ventilation through a vent. Therefore it's necessary to aerate the spaces regularly, without the intrusion of insects and small birds. The same can be applied to logistics centers and supermarkets.

To avoid these situations, our products offer two solutions: anti-bird mesh and insect mesh.

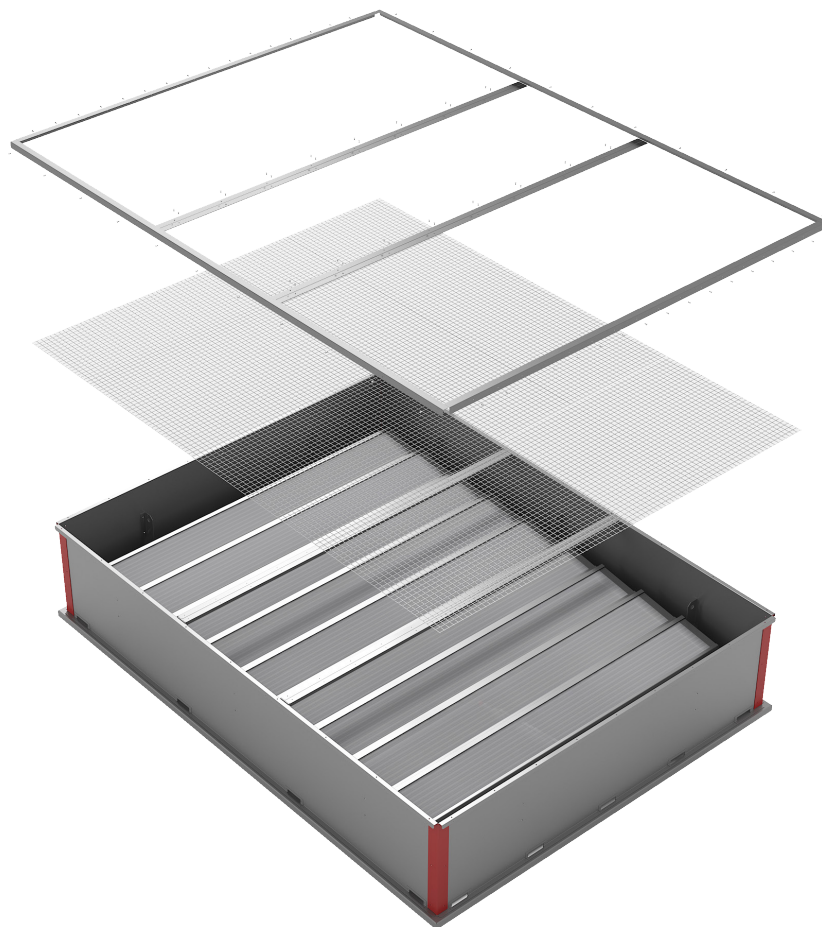

insect & bird mesh

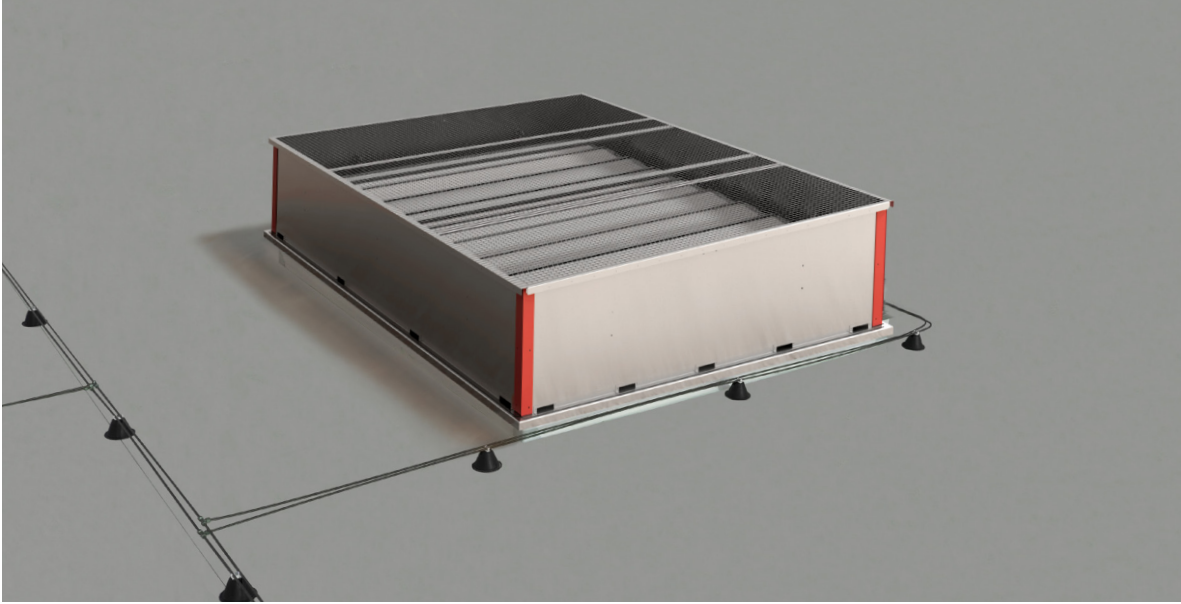

BIRD MESH

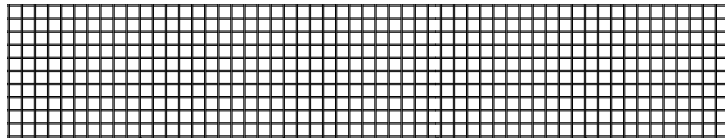

20 X 20 MM MESH

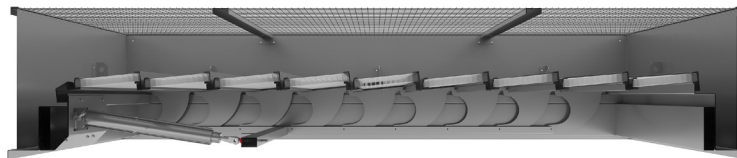

SECTION S2

Product specification: galvanized welded mesh \varnothing 2 mm. Applied on the outside of the smoke vent. W x L = 20x20 mm mesh.

INSECT MESH

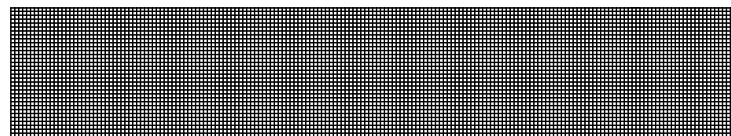

1.1 X 1.35 mm MESH

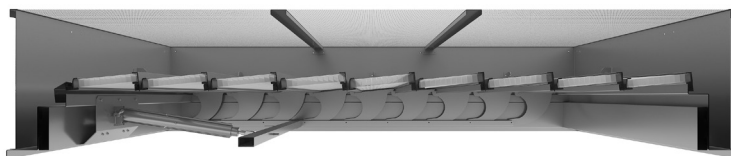

SECTION S2

Product specification: aluminium insect mesh. Applied on the outside of the smoke vent.

BIRD MESH

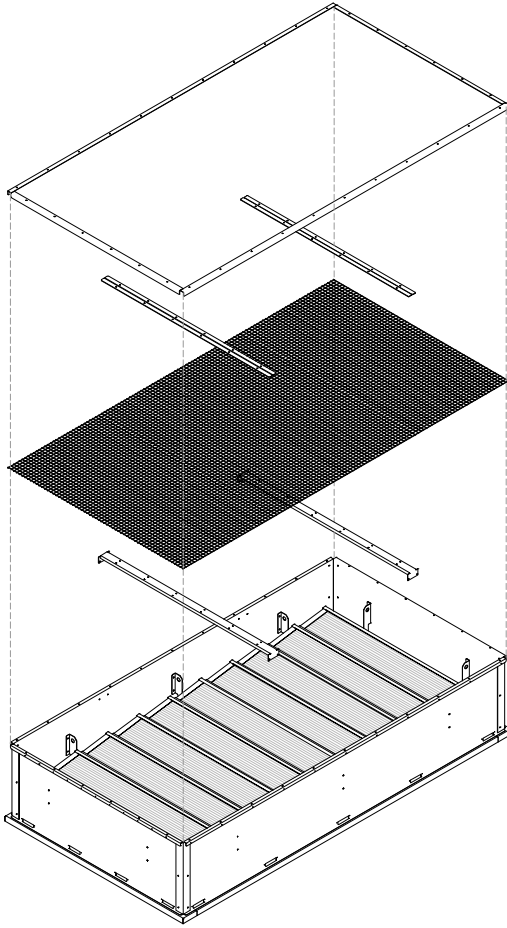

ASSEMBLY

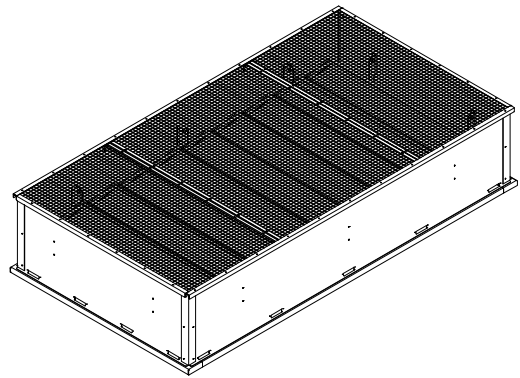

PERSPECTIVE VIEW

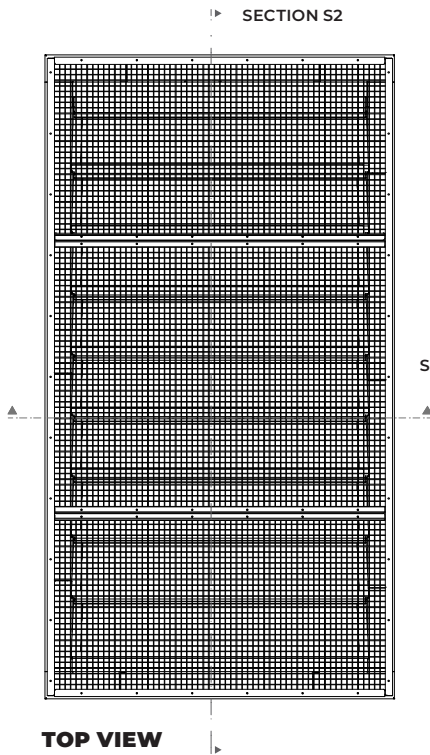

TOP VIEW

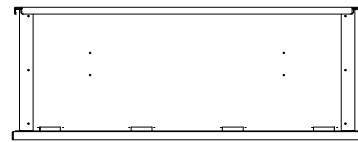

FRONT VIEW

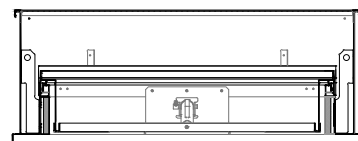

SECTION S1

INSECT MESH

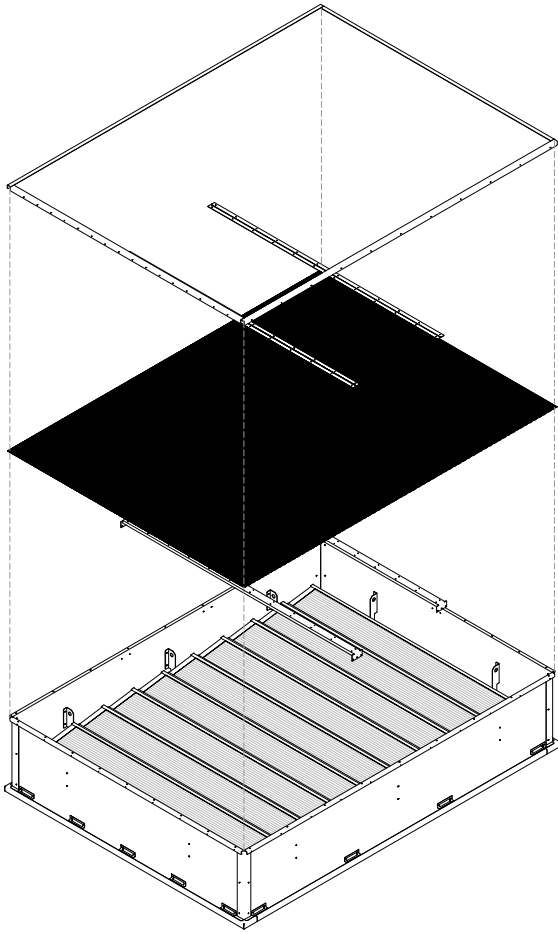

ASSEMBLY

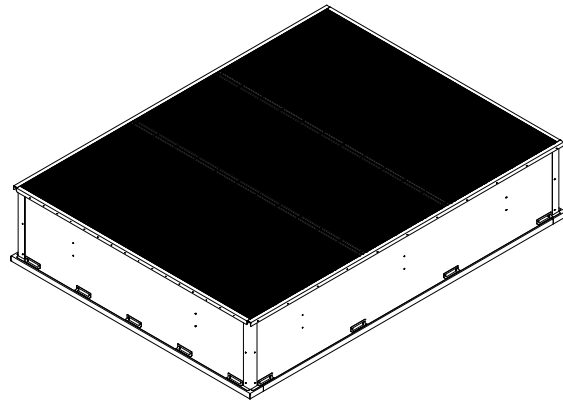

PERSPECTIVE VIEW

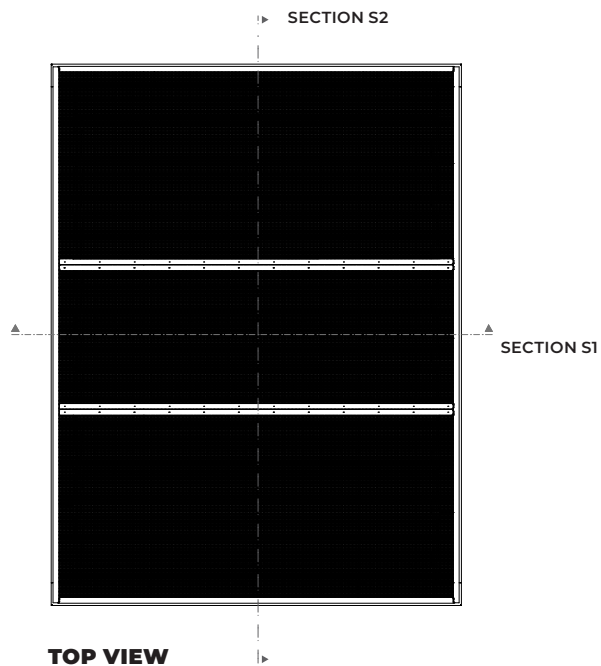

TOP VIEW

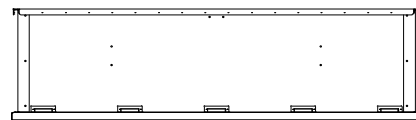

FRONT VIEW

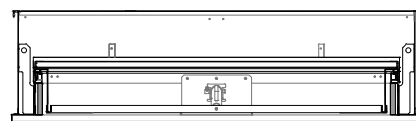

SECTION S1