

PRODUCT FEATURES

The ENZO 2 ventilation system is used as a high-performance ventilator in hot and noisy heavy-industry applications when high-volume, rainproof and energy-free ventilation is required, and which, if necessary, is also able to comply with additional noise-insulation regulations. ENZO uses the pressure and temperature difference caused by the thermal load within a building to produce natural ventilation.

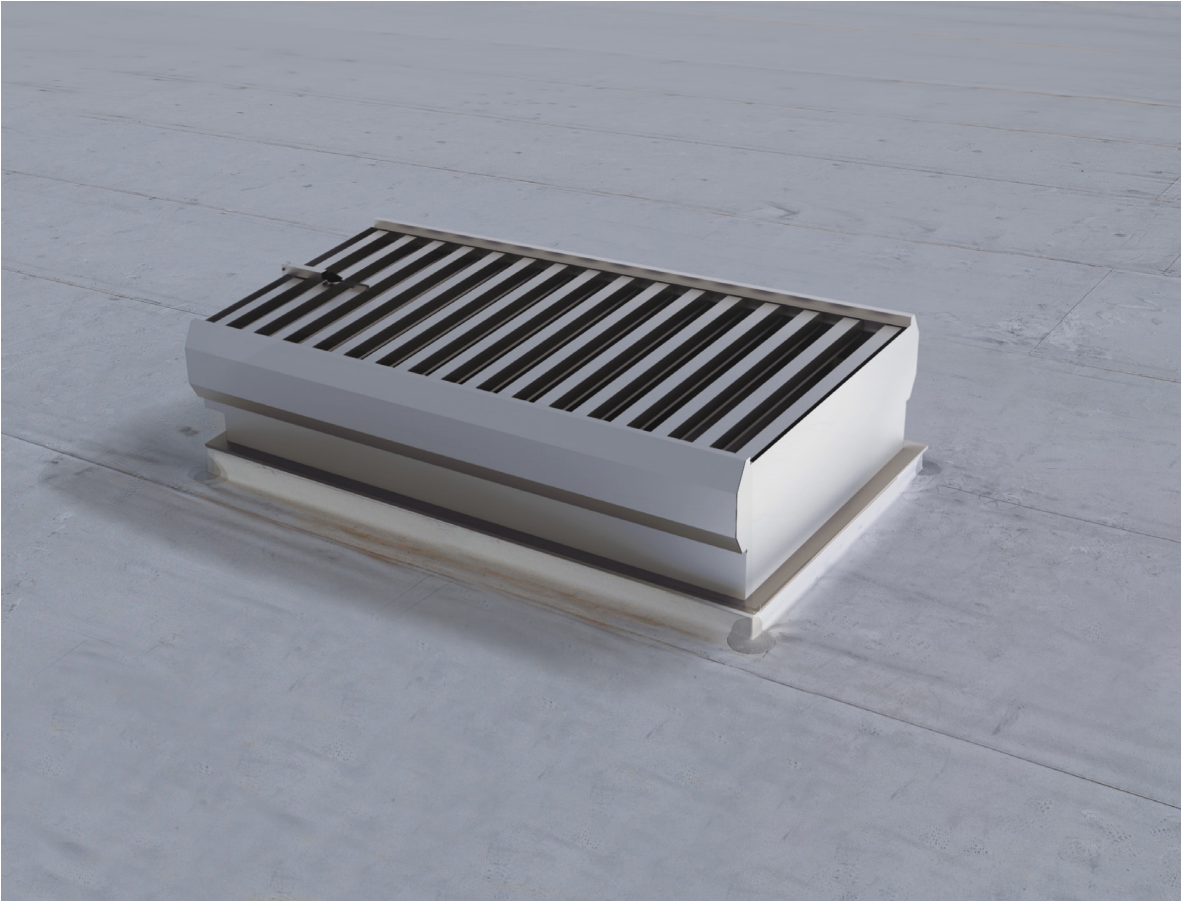



ADVANTAGES

- Individually adaptable to all types of building;
- Mountable on all common roof designs;
- Aerodynamically efficient louvre-blade shape with raised edges in the middle and on the upstream side allows for continuous weatherproof ventilation. The water that accumulates in the louvres is conducted into two drainage channels on the longitudinal edge of the unit and drained off onto the roof;
- The rain-drainage channels consist of wind deflector plates, considerably improving ventilation in inflowing-wind conditions;
- To save energy during shutdown periods, the louvres (optional) can be shut by means of a locking mechanism;
- Additional nylon brushes (optional) on the locking mechanism increase the sealing effect;
- By removing the wind deflector plates, the louvres are easily accessible and can be easily cleaned;
- Due to the flat design and the resulting low windage area, the substructures on the building can be reduced to a minimum;
- Can be fitted with splitter attenuators either on or under the roof;
- Good aerodynamic efficiency;
- Powder coating allows individual choice of colours;
- Plinth mounting using tension locks – no drill holes needed (optional);
- Low maintenance due to simple and robust design.

DESIGN CHARACTERISTICS

The ENZO is made of aluminium (AlMg3) as standard. An additional locking mechanism (optionally available with sealing brushes) prevents unnecessary energy loss during shutdown periods. The locking mechanism with rollers sliding in guide rails can be controlled electrically or pneumatically. Additional splitter attenuators can be fitted in a raised base if this is necessary due to high noise levels caused by the production processes. The splitters are located underneath the ENZO construction. The splitter frames are made of galvanized steel sheet. The absorption material is moisture-repellent and abrasion-resistant. The ventilator can be delivered with an empty housing and equipped with splitter attenuators at a later date.

LOCKING MECHANISM

To prevent heat loss during shutdown periods, an additional locking mechanism is necessary, which can be ordered optionally. This allows the ventilator to be closed or the air volume to be regulated. The sliding louvres are combined in groups, which are laterally supported by polyamide rollers.

For additional sealing, the locking louvres can be fitted with nylon brushes. The locking-mechanism actuator is either:

- a double-acting maintenance-free pneumatic cylinder with a bellow
- or a low-maintenance electric motor.

DIMENSIONS

The maximum width of the ENZO 2 is limited to 3,800 mm. The unit can be built in any length as required; drive units must, however, be fitted at specified intervals when a locking mechanism is used. Apart from the two versions A1 and A2 with the optional locking mechanism there are four different unit heights.

TYPE	BASE HEIGHT	UNIT HEIGHT
200*	200 mm*	700 mm
500	490 mm	990 mm
750	735 mm	1235 mm
1000	980 mm	1480mm

*not suitable for the installation of splitter attenuators.

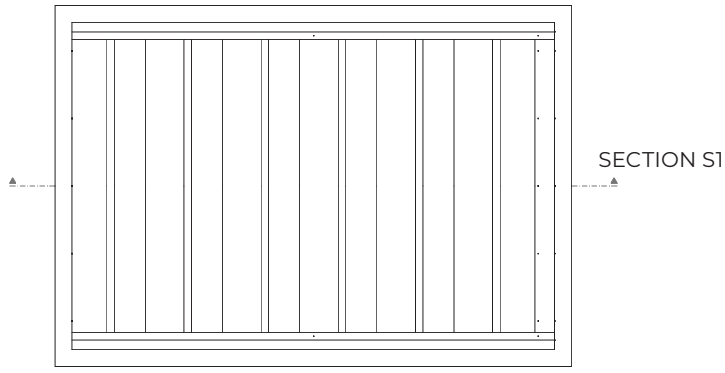

TOP VIEW

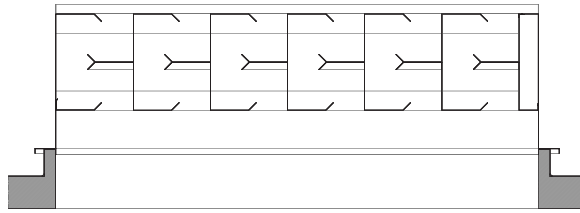

SECTION S1

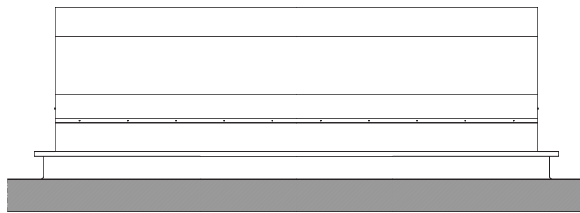

SIDE VIEW

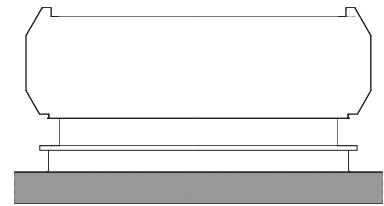

FRONT VIEW

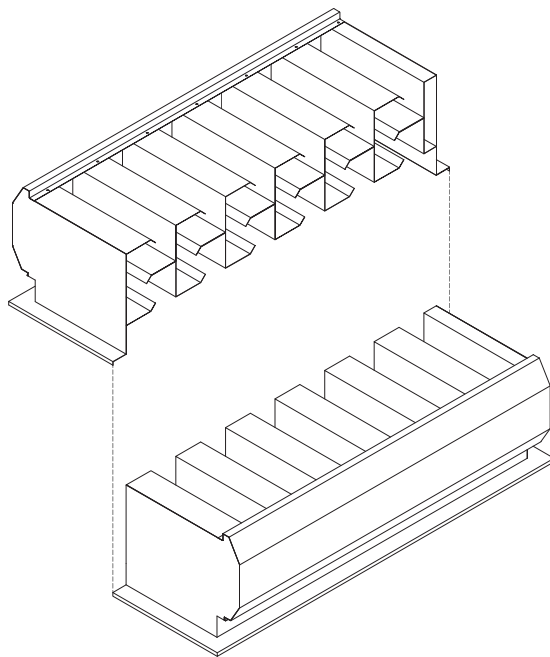

PERSPECTIVE - SECTION S1

AIRFLOW 01

The ENZO 2 A1 allows the required airflow when combined with a sufficiently large roof opening. The ratio between the splitter-attenuator housings and the width of the air openings is 1:1, allowing a high sound-insulation value.

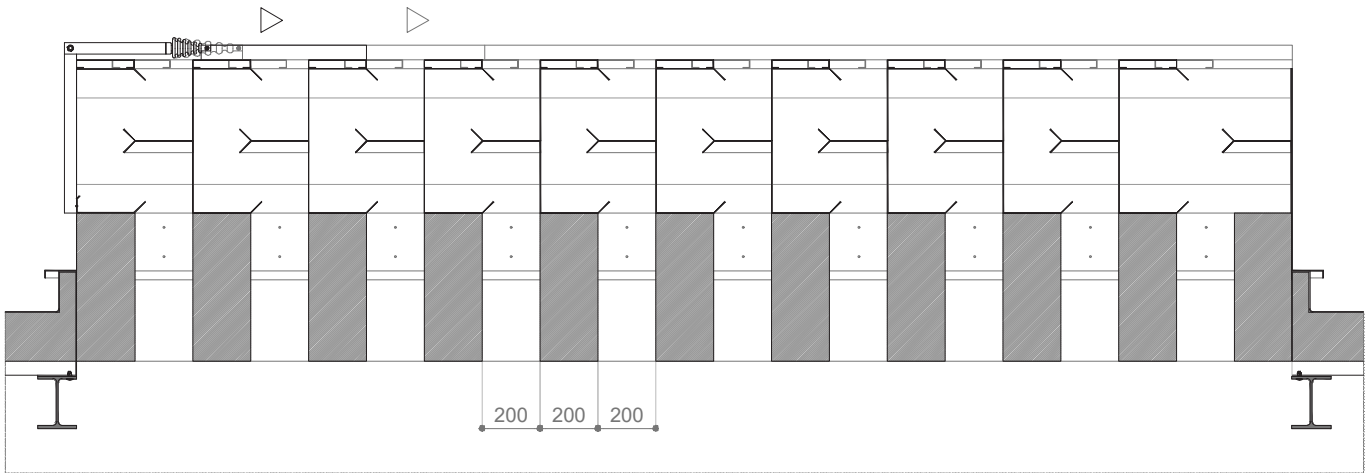

AIRFLOW 1 with splitter attenuator and locking mechanism (optional).

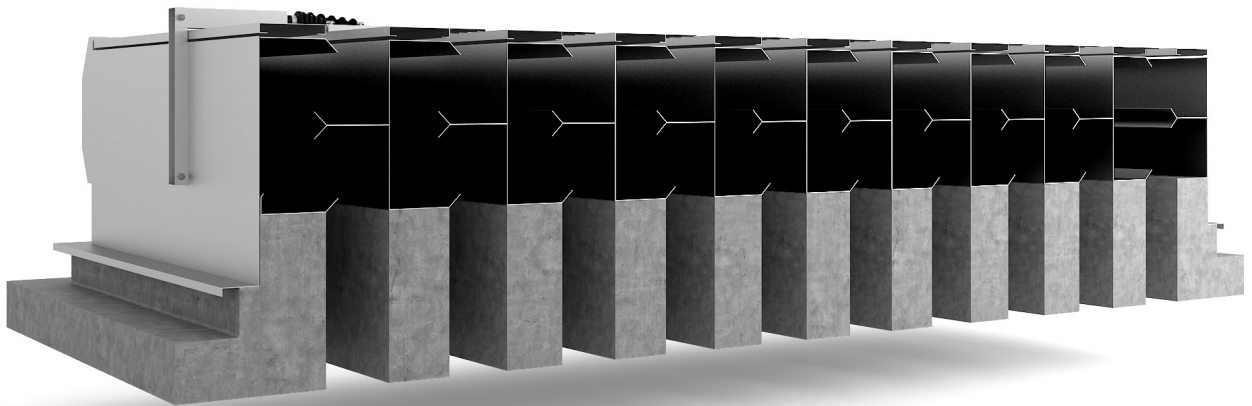

PROFILE CLOSED

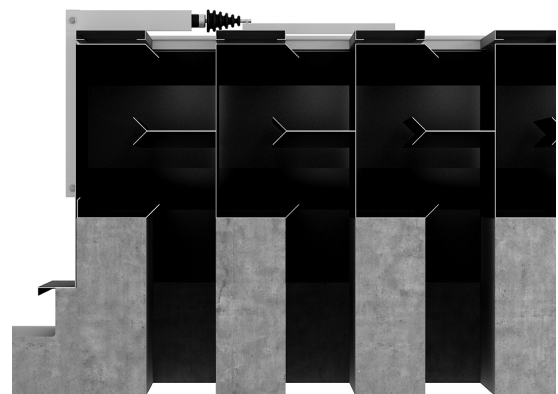

PROFILE OPEN

AIRFLOW 02

In the case of the ENZO 2 A2 version, the system has a more aerodynamic design, which, having an improved flow-rate coefficient (CV), allows increased airflow with a smaller roof opening. The ratio between the splitter-attenuator housings and the width of the air openings is 1:1.5.

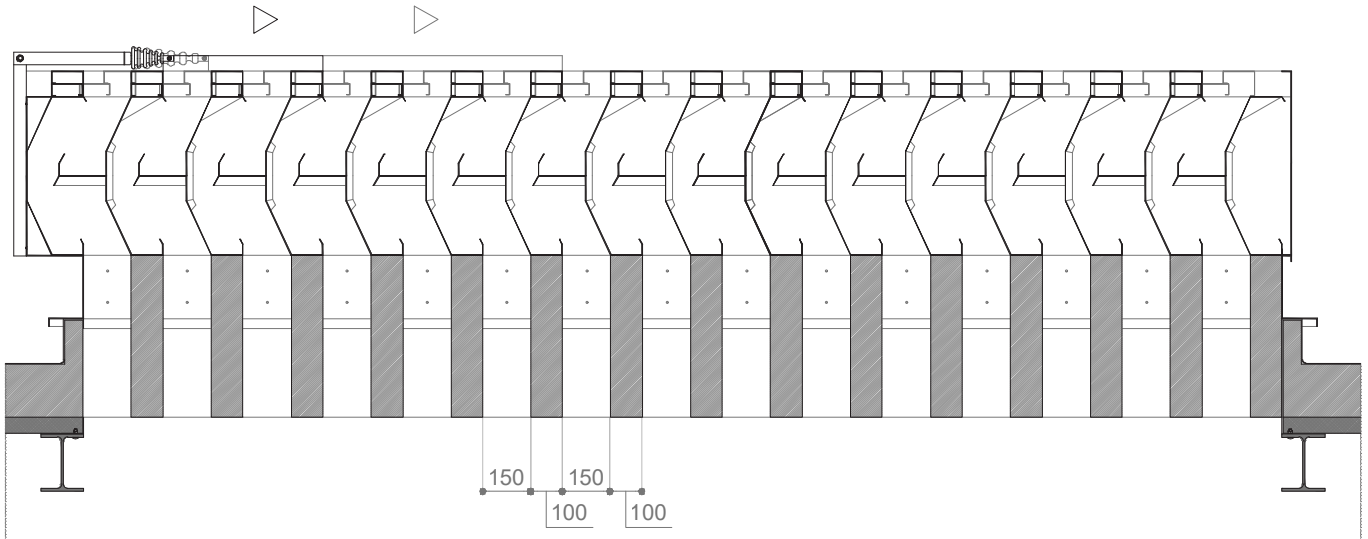

AIRFLOW 2 with splitter attenuator and double slider (optional).

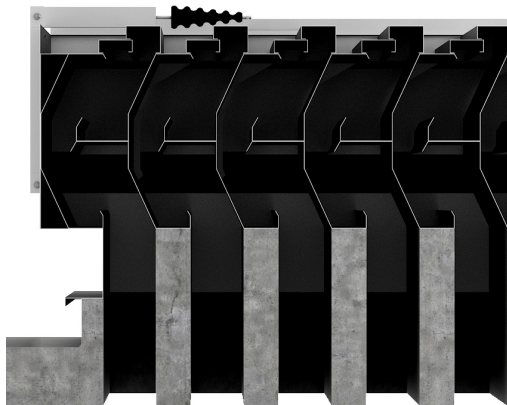
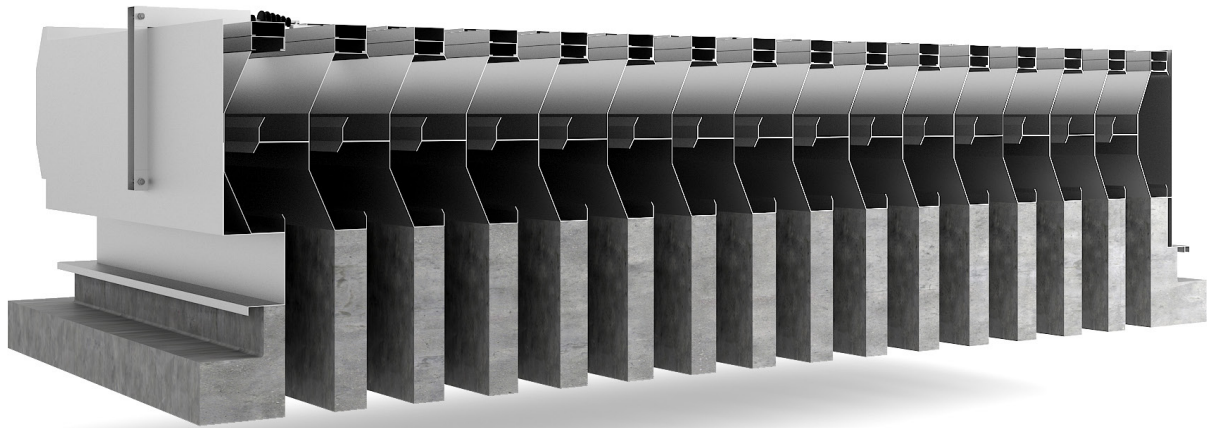

PROFILE CLOSED

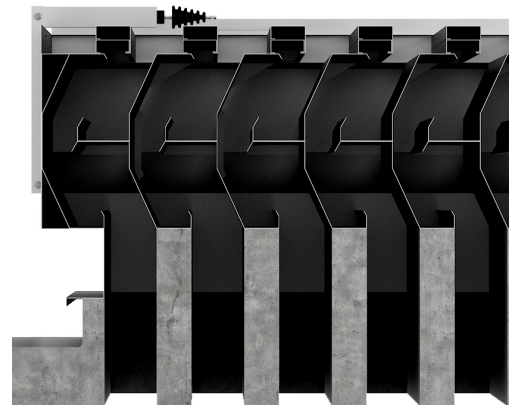

PROFILE OPEN