



PRODUCT FEATURES

MEGADELTA is a double flap vent suitable for all-weather ventilation of warm air and / or smoke from a building within a short period of time, daily ventilation and natural lighting.

It is equipped with lateral inner flaps to enable weather-protected ventilation. As soon as the outer flaps close due to rain, the inner flaps open. The flaps are closed by a spring mechanism. The changeover from fair-weather ventilation to weather-protected ventilation is controlled by a rain-sensor system. Suitable for utilization on various kerbs and domes. The vents are manufactured according to ISO 9001 quality control standards and comply with the European requirements for NSHE according to EN 12101-2. Endurance tests with 10,000 opening and closing cycles have proven its robust and functional design. The vents are formed from high quality corrosion resistant aluminium to ensure low maintenance requirements and water tightness.

Various methods of operation using pneumatic or electric actuators are available. Available on large dimensions, up to 1900 x 3000 mm (width x length).

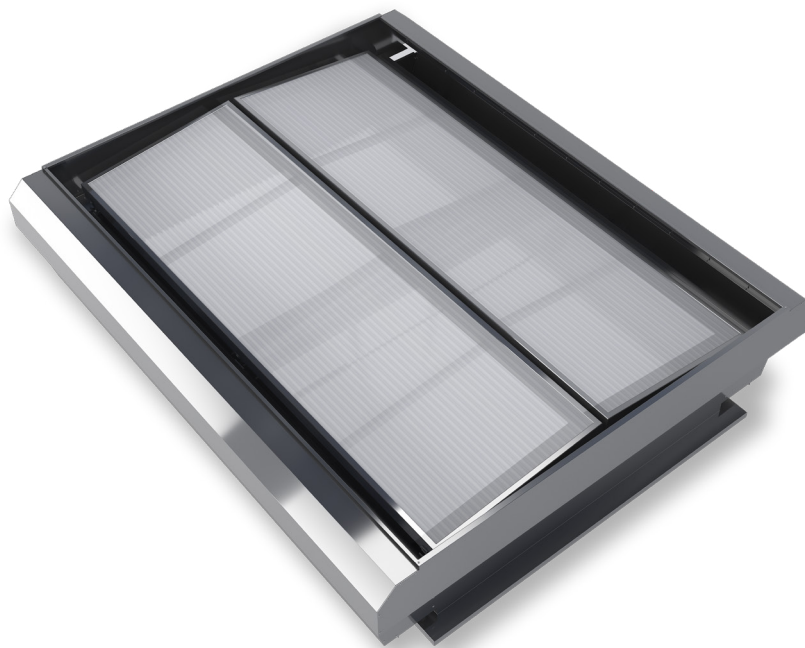

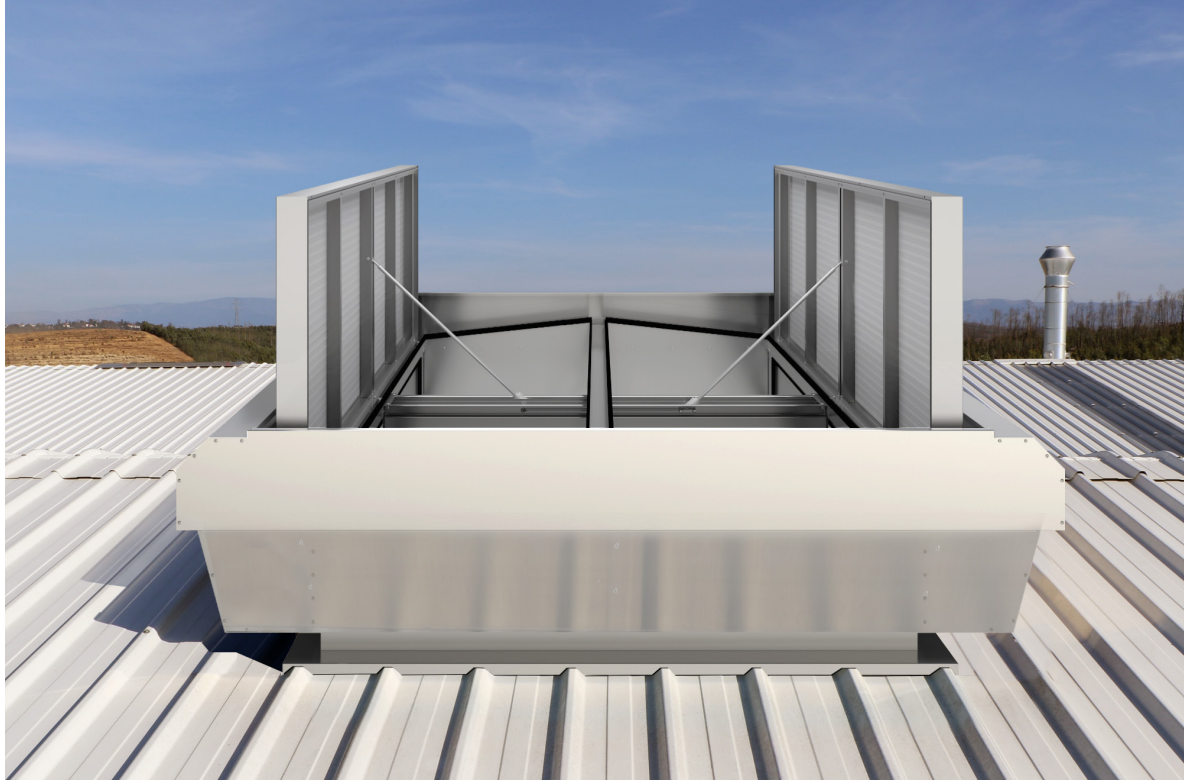

TYPICAL APPLICATIONS

Can be installed either into roofs or barrel vault daylighting systems (flat roofs, skylights and northlight roofs). Particularly suitable for warehouses, logistics centres, production environments and industries.

MATERIALS

Tempered aluminium, sea water and corrosion resistant (EN AW 5754).
Corrosion resistant bearings.
Sealant applied so that there is no freezing, enabling the equipment to have low air permeability at the same time.

Note: aluminum is supplied untreated as standard. Possibility of being supplied with electrostatic painting (in any RAL color).

DIMENSIONS

Roof opening width: 1000 - 1900 mm.
Roof opening length: 1000 - 3000 mm.

OPENING ANGLE

Open angle from 0° up to 90°.

CONTROLS NATURAL VENTILATION

P1: compressed air opening and spring closing.
M24V: electric motor.
M230V: electric motor.

CONTROLS FIRE VENTILATION

P2F: double pipe compressed air operation with fire function.
M24V: electric motor.

FLAPS

- AL** Single aluminium.
- AL ISO** Double insulated aluminium (ISO thickness 20 and 50 mm).
- PC16** Polycarbonate 16 mm, clear or opal.
- PC25** Polycarbonate 25 mm, clear or opal.
- PC32** Polycarbonate 32 mm, clear or opal.
- TB** Thermal break in the aluminium profiles. Available for flaps of AL ISO, PC25 mm, PC32 mm.



PC16



PC25

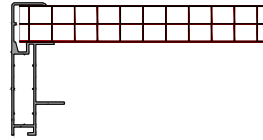

PC32

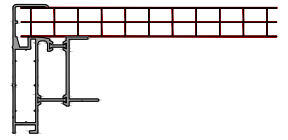

PC25 TB

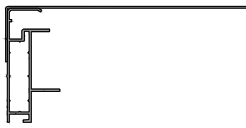

AL



AL ISO 20

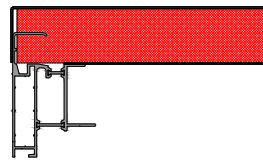

TB AL ISO 50

BASES

- Single aluminium.
- Double wall aluminium with insulation.
- Double wall aluminium with insulation and TB, thermal break in the aluminium base.

Note: other non-standard bases available upon request.

FLANGES

- S1** Flange for single glass.
- S2** Flange for double glass.
- S3** Flange for roofs, 45° bended.
- S4** Flange for roofs and facades.
- S5** Flange for upstand, 90° bended downwards.
- S6** Flange 90° bended upwards.
- SLS** Flange for skylight connection, for different polycarbonate thicknesses.
- SC** Flange for connection with other flange (vents connection). Male or female connection.
- SCM** Flange for male connection.
- SCF** Flange for female connection.

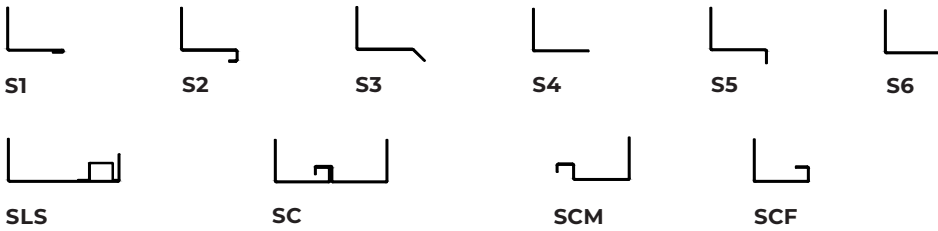

WEIGHT

Depends on dimensions and type of material.

OPTIONS

- Custom dimensions.
- Powder-coated design (any RAL colour).
- Bird or insect mesh/Anti-fall grid 1200 J.

REGULATIONS

The system has been tested and is certified in accordance with EN 12101-2.
 Tested in accordance with the Directive 2014/34/EU, DELTA is ATEX certified equipment.

STANDARD INTERIOR DIMENSIONS

TYPE	1010	1015	1020	1025	1020	1310	1315	1320	1325	1330
WIDTH (mm)	1000					1250				
LENGTH (mm)	1000	1500	2000	2500	3000	1000	1500	2000	2500	3000

TYPE	1510	1515	1520	1525	1530	1910	1915	1920	1925	1930
WIDTH (mm)	2000					1900				
LENGTH (mm)	1000	1500	2000	2500	3000	1000	1500	2000	2500	3000

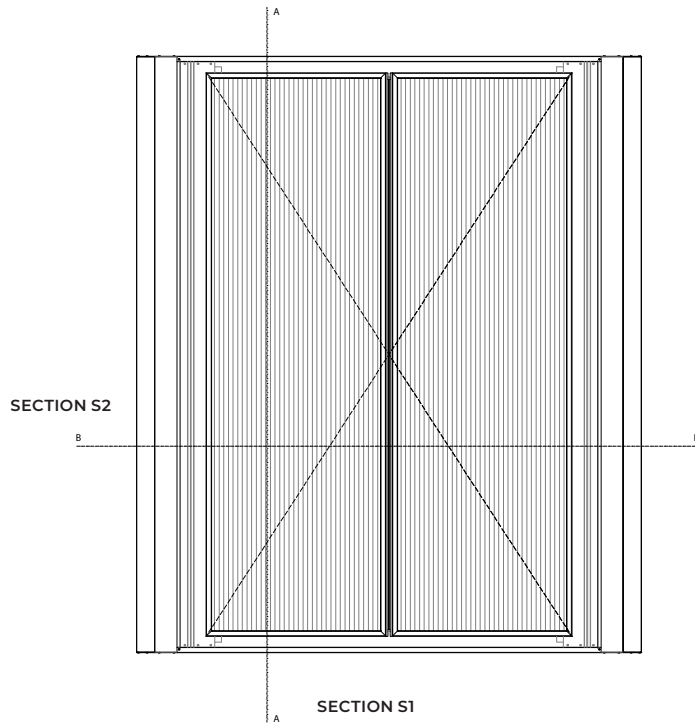

TOP VIEW

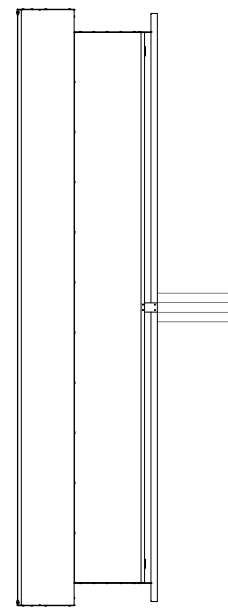

SIDE VIEW CLOSED

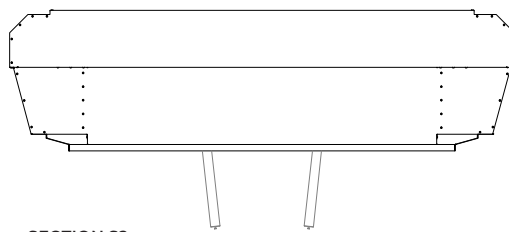

FRONT VIEW CLOSED

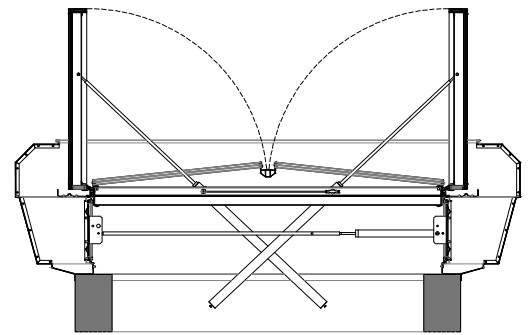

FRONT VIEW OPEN

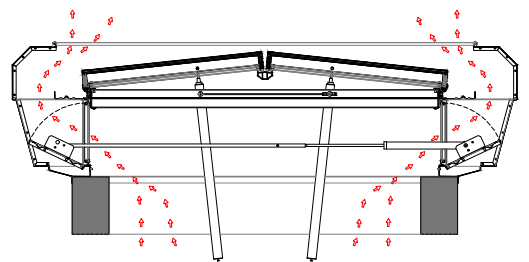

CLOSED VENT | OPENED VENTILATION

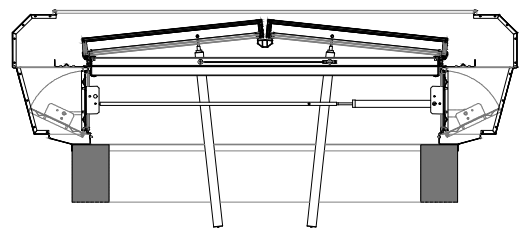

CLOSED VENT | CLOSED VENTILATION